

900 Van Gogh Built In Double Sided

The Built-In Van Gogh double sided redefines modern home design, offering a sophisticated fireplace solution. Its flush installation creates a streamlined look, integrating seamlessly with your walls for a minimalist aesthetic. Perfect for creating a focal point in living rooms, bedrooms, or dining areas, it's a statement piece that elevates any interior. The double-sided option adds versatility, allowing it to enhance a single space or connect two rooms with warmth and style. Designed for those who appreciate understated luxury, the Built-In Van Gogh brings both comfort and timeless elegance to your home

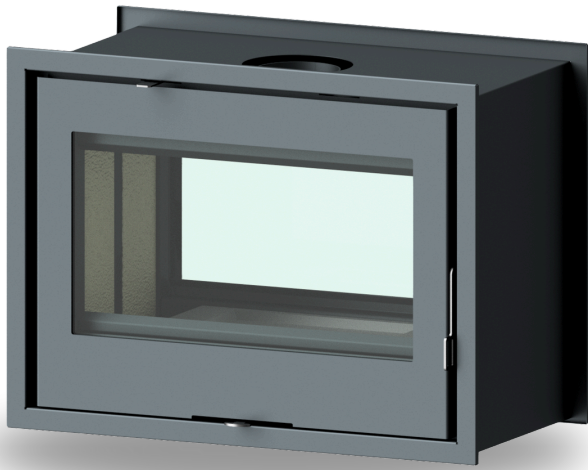

	17 kW
	250m ³
	135kg
	855mm
	645mm
	475mm
	150mm
	84%

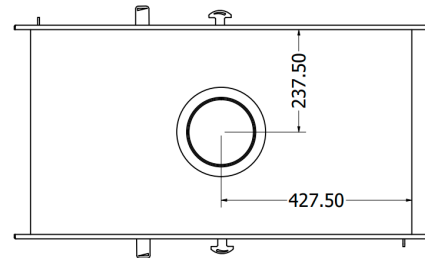
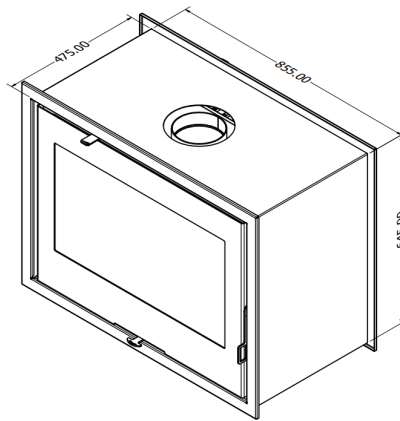
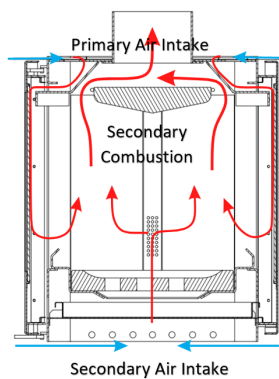

The Built In Van Gogh double sided boasts a dual intake system, featuring a primary and secondary intake. The dual controls, accessible from both sides via protruding levers, ensure efficient airflow regulation. While the front and back vents move in sync and aren't adjustable separately, they work in tandem to optimize combustion. Air enters the unit's outer box at the top, where it's heated by conduction from the combustion chamber. This heated air then passes through the controllable vent over the glass, serving as an air-wash system. Not only does this keep the viewing glass free of soot, but it also delivers preheated air back to the combustion chamber, enhancing overall efficiency.