

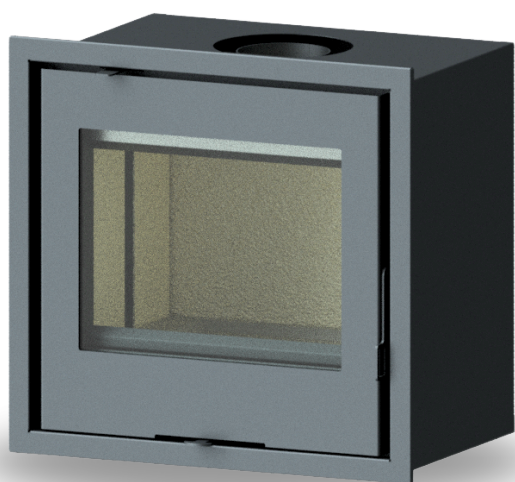







700 Van Gogh Built In

The Built-In Van Gogh redefines modern home design, offering a sophisticated fireplace solution. Its flush installation creates a streamlined look, integrating seamlessly with your walls for a minimalist aesthetic. Perfect for creating a focal point in living rooms, bedrooms, or dining areas, it's a statement piece that elevates any interior. The double-sided option adds versatility, allowing it to enhance a single space or connect two rooms with warmth and style. Designed for those who appreciate understated luxury, the Built-In Van Gogh brings both comfort and timeless elegance to your home



	12 kW
	130m ³
	105kg
	655mm
	645mm
	480mm
	150mm
	84%

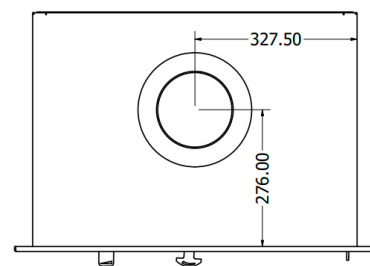
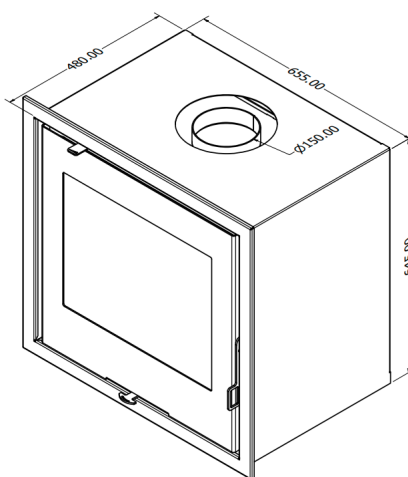
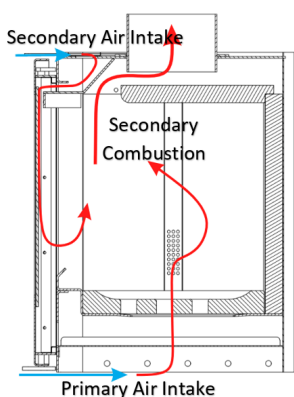

The Built-In Van Gogh boasts a dual intake system, featuring a primary and secondary intake. The primary intake ensures airflow directly from the bottom grate and side vents. Air enters the unit's outer box at the top, where it's heated by convection from the combustion chamber. This heated air then passes through the controllable vent over the glass, serving as an air-wash system. Not only does this keep the viewing glass free of soot, but it also delivers preheated air back to the combustion chamber, enhancing overall efficiency.